

- VBB 1
- MPP2 2
- MPP1 3
- MPP4 4
- MPP3 5
- RX 6
- INJ2 7
- INJ1 8
- VREF 9
- INOILT 10
- INTHROT 11
- GNDPOW 12
- PRG 13
- INENGPOS 14
- GNDINJ 15
- IGN2 16
- GNDIECU 17
- INAIRT 18
- INENGT 19
- INLAMBDA1 20
- TX 21
- GNDIGN 22
- IGN1 23

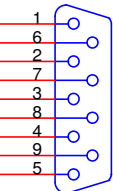

FEMALE
CONNECTOR DB9

+12V for ECU programming

Title		
BiRace - Communications		
Size	Document Number	Rev
A3	BiRace-3	<RevCode>
Date:	Tuesday, April 01, 2003	Sheet 1 of 1

- VBB 1
- MPP2 2
- MPP1 3
- MPP4 4
- MPP3 5
- RX 6
- INJ2 7
- INJ1 8
- VREF 9
- INOILT 10
- INTHROT 11
- GNDPOW 12
- PRG 13
- INENGPOS 14
- GNDINJ 15
- IGN2 16
- GNDECU 17
- INAIRT 18
- INENGT 19
- INLAMBDA1 20
- TX 21
- GNDIGN 22
- IGN1 23

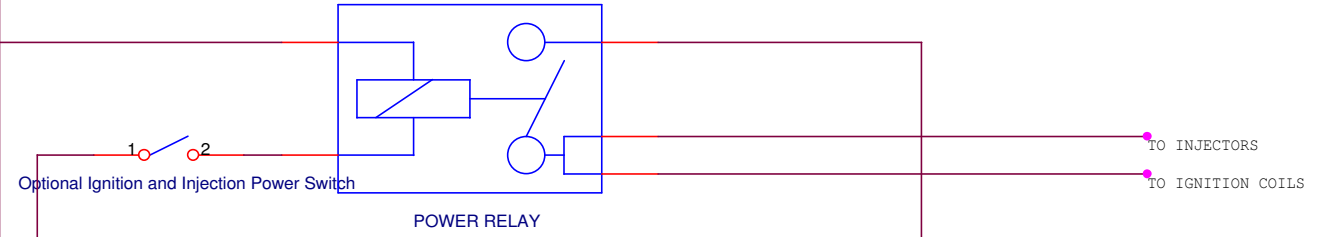
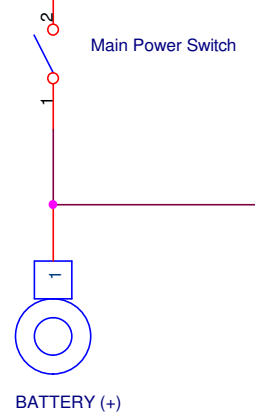
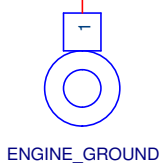

Title		
BiRace - Power		
Size	Document Number	Rev
A3	BiRace-0	<RevCode>
Date:	Tuesday, April 01, 2003	Sheet 1 of 1

- 1 VBB
- 2 MPP2
- 3 MPP1
- 4 MPP4
- 5 MPP3
- 6 RX
- 7 INJ2
- 8 INJ1
- 9 VREF
- 10 INOILT
- 11 INTHROT
- 12 GNDPOW
- 13 PRG
- 14 INENGPOS
- 15 GNDINJ
- 16 IGN2
- 17 GNDECU
- 18 INAIRT
- 19 INENGT
- 20 INLAMBDA1
- 21 TX
- 22 GNDIGN
- 23 IGN1

JOIN THE GROUNDS AS CLOSE AS POSSIBLE TO THE ECU CONNECTOR

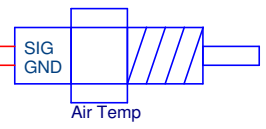
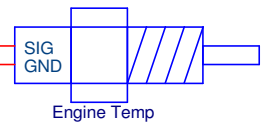
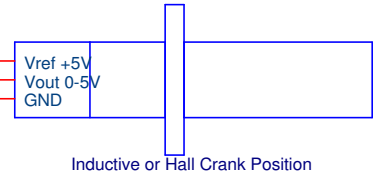
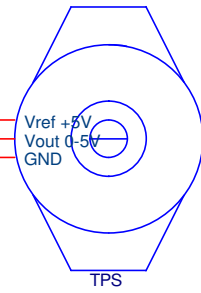

Title		
BiRace Sensors		
Size	Document Number	Rev
A3	BiRace-1	<RevCode>
Date:	Tuesday, April 01, 2003	Sheet 1 of 1

- VBB 1
- MPP2 2
- MPP1 3
- MPP4 4
- MPP3 5
- RX 6
- INJ2 7
- INJ1 8
- VREF 9
- INOILT 10
- INTHROT 11
- GNDPOW 12
- PRG 13
- INENGPOS 14
- GNDINJ 15
- IGN2 16
- GNDECU 17
- INAIRT 18
- INENGT 19
- INLAMBDA1 20
- TX 21
- GNDIGN 22
- IGN1 23

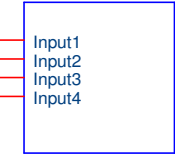

Idle Valve

Title		
BiRace - Idle Valve'		
Size	Document Number	Rev
A3	BiRace-2-1	<RevCode>
Date:	Tuesday, April 01, 2003	Sheet 1 of 1

- 1 VBB
- 2 MPP2
- 3 MPP1
- 4 MPP4
- 5 MPP3
- 6 RX
- 7 INJ2
- 8 INJ1
- 9 VREF
- 10 INOILT
- 11 INTHROT
- 12 GNDPOW
- 13 PRG
- 14 INENGPOS
- 15 GNDINJ
- 16 IGN2
- 17 GNDECU
- 18 INAIRT
- 19 INENGT
- 20 INLAMBDA1
- 21 TX
- 22 GNDIGN
- 23 IGN1

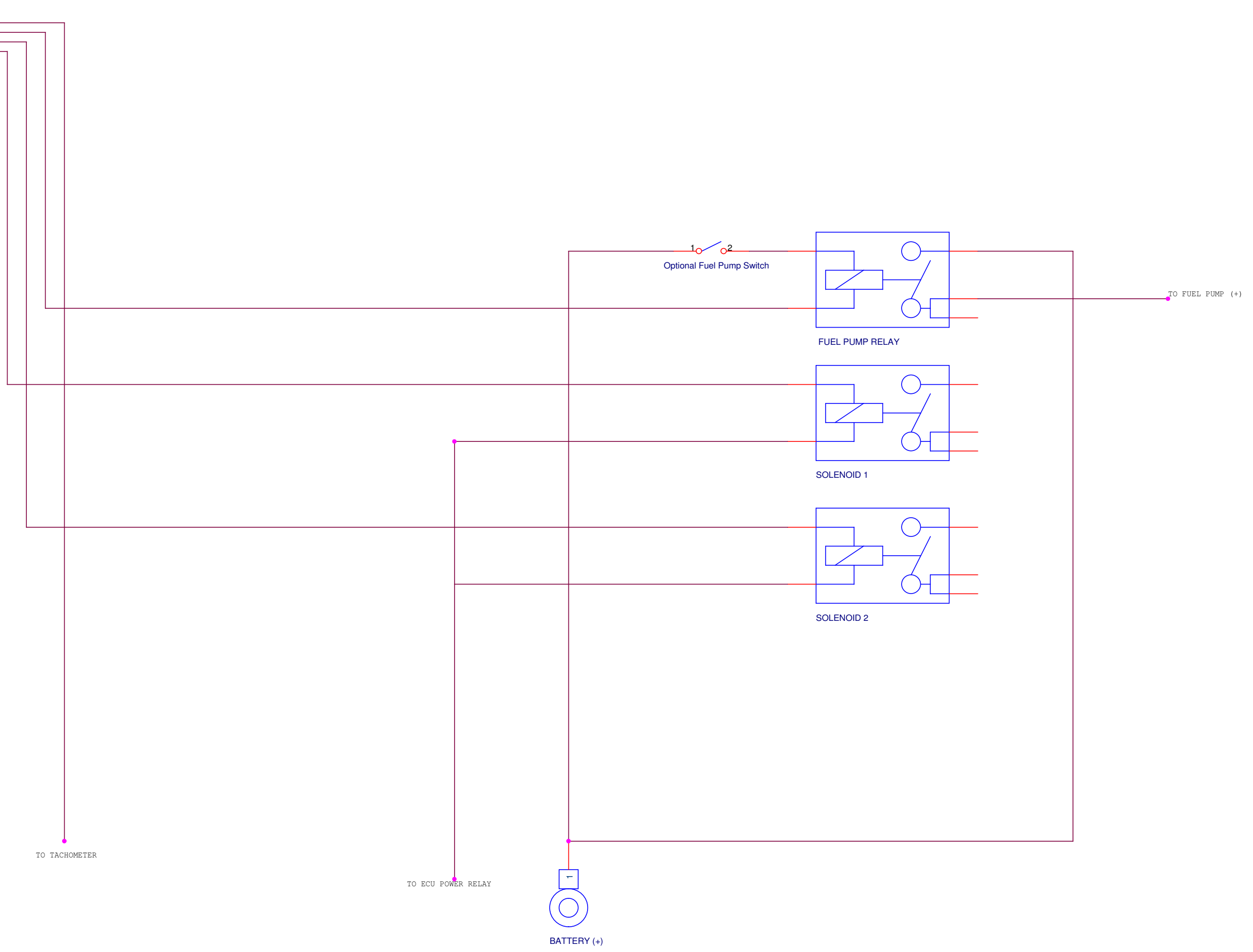

Title		
BiRace - Multifunction Driver		
Size	Document Number	Rev
A3	BiRace-2-2	<RevCode>
Date:	Tuesday, April 01, 2003	Sheet 1 of 1