

Note: Use shielded wire as close as possible to the ECU connector!

Note: Join these wires as close as possible to the ECU connector!

Vsig 0-5V
GND
LAMBDA1

Vsig 0-5V
GND
LAMBDA2

Vsig 0-5V
GND
Amplifier with Vsig 0-5V

SIG
GND
EXHAUST TEMPERATURE SENSOR

SIG
GND
SHIELD

Inductive Wheel Speed

Vref
Vsig
GND

Hall Wheel Speed

1 2
Gear Shift Trigger

1 2
Dual Map Switch

Title		Race 600 - Optional Sensors	
Size	A3	Document Number	Race600-2
Date:	Tuesday, April 15, 2003	Rev	<RevCode>
Date:		Sheet	1 of 1

PL1
 A
 B
 C
 D
 E
 F
 G
 H
 J
 K
 L
 M
 N
 P
 R
 S
 T
 U
 V
 W
 X
 Y
 Z
 a
 b
 c
 d
 e
 f
 g
 h
 i
 j
 k
 m
 n
 p
 q
 r
 s
 t
 u
 v
 w
 x
 y
 z
 AA
 BB
 CC
 DD
 EE
 FF
 GG
 HH

Note: Use shielded wire as close as possible to the ECU connector!

Note: Use shielded wire as close as possible to the ECU connector!

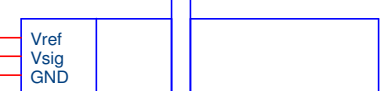
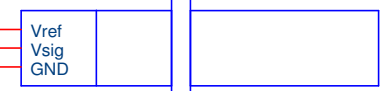
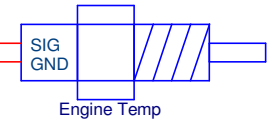
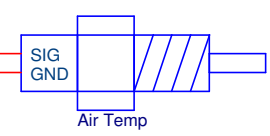
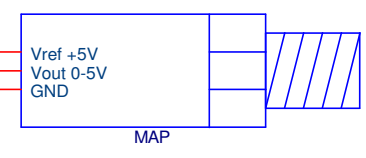
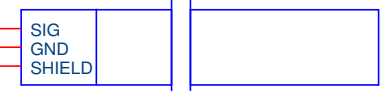
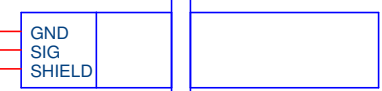
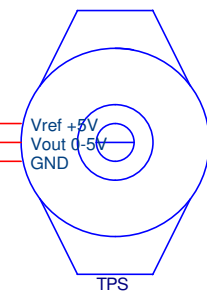
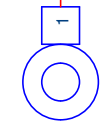

Title		
Race 600 - Required Sensors		
Size	Document Number	Rev
A3	Race600-1	<RevCode>
Date:	Tuesday, April 15, 2003	Sheet 1 of 1

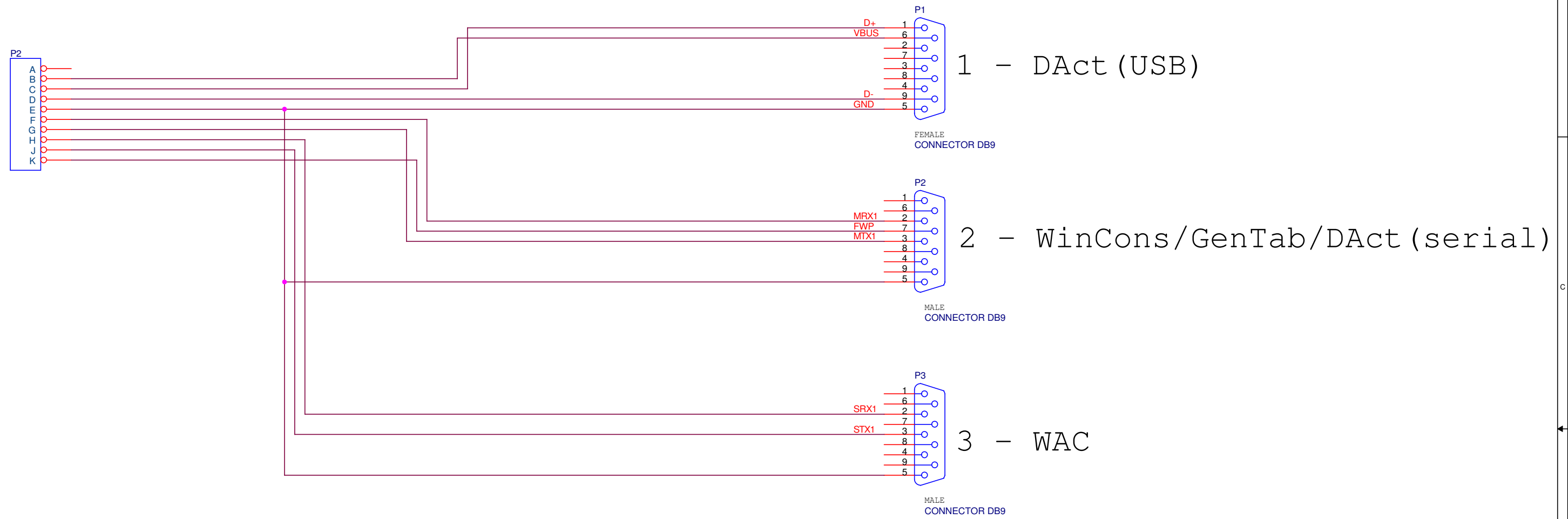

Title		
Race 600 - Communications		
Size	Document Number	Rev
A3	Race600-5	<RevCode>
Date:	Tuesday, April 15, 2003	Sheet 1 of 1

PP1

- A
- B
- C
- D
- E
- F
- G
- H
- J
- K
- L
- M
- N
- P
- R
- S
- T
- U
- V
- W
- X
- Y
- Z
- a
- b
- c
- d
- e
- f
- g
- h
- i
- k
- m
- n
- p
- q
- r
- s
- t
- u
- v
- w
- x
- y
- z
- AA
- BB
- CC
- DD
- EE
- FF
- GG
- HH

Note: Join these wires as close as possible to the ground connector.

TO IGNITION RELAY

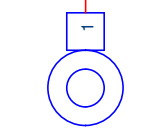

ENGINE_GROUND

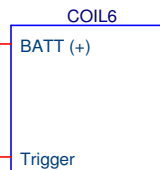
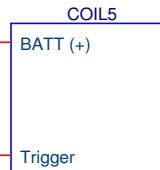
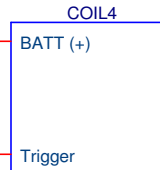
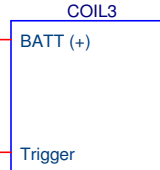
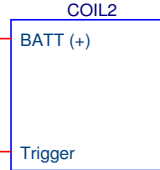
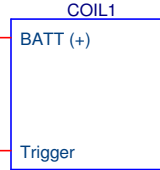

Title		
Race 600 - Ignition Coils		
Size	Document Number	Rev
A3	Race600-3	<RevCode>
Date:	Tuesday, April 15, 2003	Sheet 1 of 1

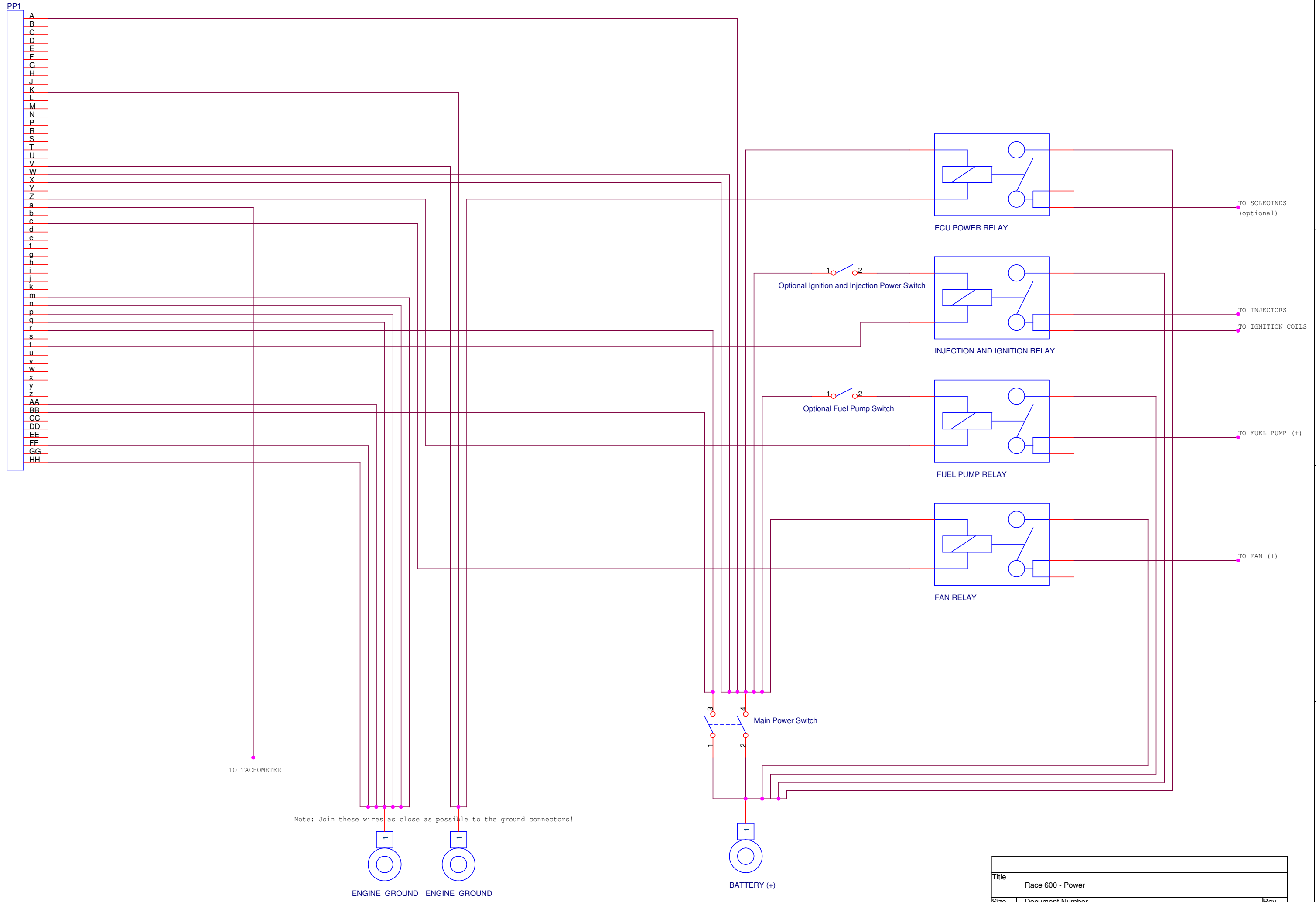

Title		
Race 600 - Power		
Size	Document Number	Rev
A3	Race600-0	<RevCode>
Date:	Tuesday, April 15, 2003	Sheet 1 of 1

PP1
 A
 B
 C
 D
 E
 F
 G
 H
 J
 K
 L
 M
 N
 P
 R
 S
 T
 U
 V
 W
 X
 Y
 Z
 a
 b
 c
 d
 e
 f
 g
 h
 i
 j
 k
 m
 n
 p
 q
 r
 s
 t
 u
 v
 w
 x
 y
 z
 AA
 BB
 CC
 DD
 EE
 FF
 GG
 HH

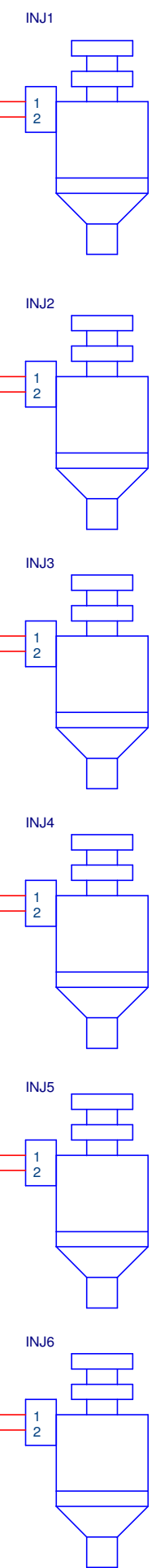

Note: Join these wires as close as possible to the ground connector.

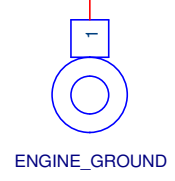

TO INJECTION RELAY

Title		
Race 600 - Injection		
Size	Document Number	Rev
A3	Race600-4	<RevCode>
Date:	Tuesday, April 15, 2003	Sheet 1 of 1

PP1

- A
- B
- C
- D
- E
- F
- G
- H
- J
- K
- L
- M
- N
- P
- R
- S
- T
- U
- V
- W
- X
- Y
- Z
- a
- b
- c
- d
- e
- f
- g
- h
- i
- j
- k
- m
- n
- p
- q
- r
- s
- t
- u
- v
- w
- x
- y
- z
- AA
- BB
- CC
- DD
- EE
- FF
- GG
- HH

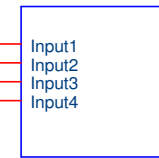

Idle Valve

Title		
Race 600 - Stepper Motor		
Size	Document Number	Rev
A3	Race600-6	<RevCode>
Date:	Tuesday, April 15, 2003	Sheet 1 of 1

PP1

- A
- B
- C
- D
- E
- F
- G
- H
- J
- K
- L
- M
- N
- P
- R
- S
- T
- U
- V
- W
- X
- Y
- Z
- a
- b
- c
- d
- e
- f
- g
- h
- i
- j
- k
- m
- n
- p
- q
- r
- s
- t
- u
- v
- w
- x
- y
- z
- AA
- BB
- CC
- DD
- EE
- FF
- GG
- HH

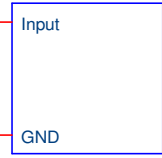

Wastegate Valve

TO ECU POWER RELAY

Title		
Race 600 - Wastegate		
Size	Document Number	Rev
A3	Race600-7	<RevCode>
Date:	Tuesday, April 15, 2003	Sheet 1 of 1

PP1
A
B
C
D
E
F
G
H
J
K
L
M
N
P
R
S
T
U
V
W
X
Y
Z
a
b
c
d
e
f
g
h
i
j
k
m
n
p
q
r
s
t
u
v
w
x
y
z
AA
BB
CC
DD
EE
FF
GG
HH

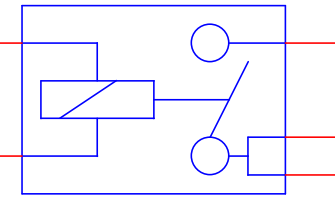
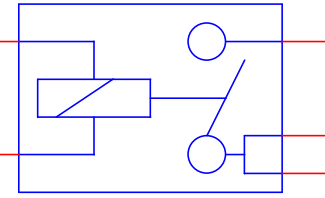

TO ECU POWER RELAY (+ output)

Title		
Race 600 - Solenoids		
Size	Document Number	Rev
A3	Race600-9	<RevCode>
Date:	Tuesday, April 15, 2003	Sheet 1 of 1

PP1

- A
- B
- C
- D
- E
- F
- G
- H
- J
- K
- L
- M
- N
- P
- R
- S
- T
- U
- V
- W
- X
- Y
- Z
- a
- b
- c
- d
- e
- f
- g
- h
- i
- j
- k
- m
- n
- p
- q
- r
- s
- t
- u
- v
- w
- x
- y
- z
- AA
- BB
- CC
- DD
- EE
- FF
- GG
- HH

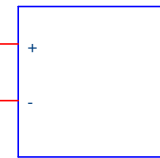

Idle Valve

Title		
Race 600 - Idle Duty-Cycle		
Size	Document Number	Rev
A3	Race600-8	<RevCode>
Date:	Tuesday, April 15, 2003	Sheet 1 of 1